

Teanga

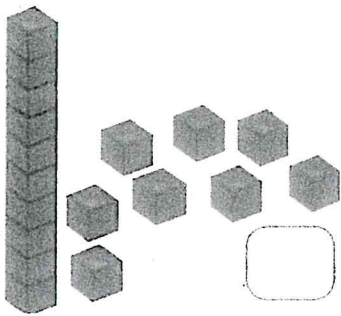

na

matamaitice

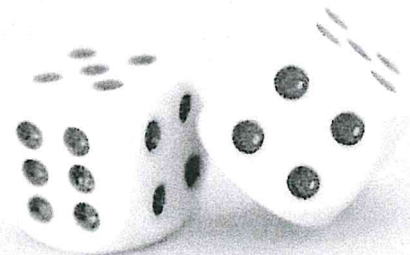
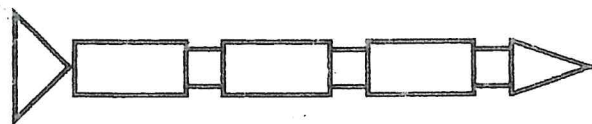

Rang 1

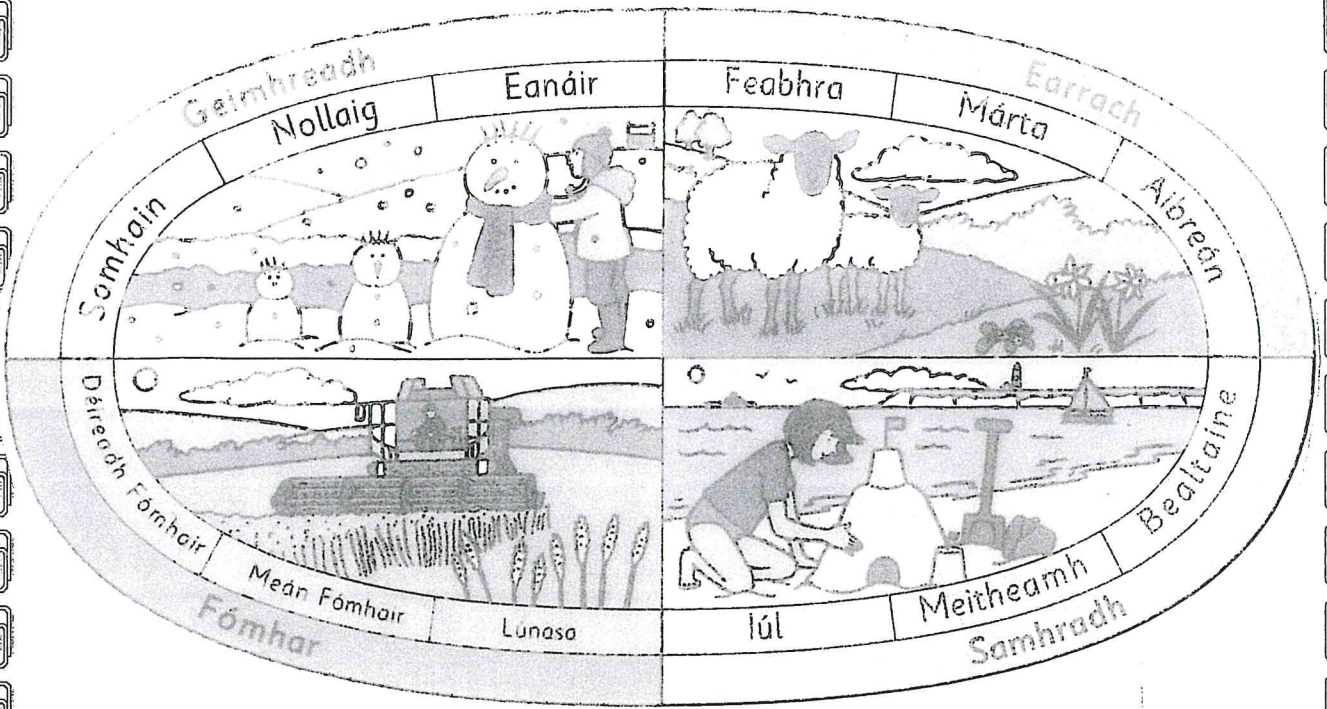

Na Séasúir		
An Fómhar	San Fómhar	Le linn an Fómhair
An Geimhreadh	Sa Gheimhreadh	Le linn an Gheimhridh
An tEarrach	San Earrach	Le linn an Earraigh
An Samhradh	Sa Samhradh	Le linn an tSamhraidh

an Luan	dé Luain	Eanáir	31
an Mháirt	dé Máirt	Feabhra	28
an Chéadaoin	dé Céadaoin	Márta	31
an Déardaoin	Déardaoin	Aibreán	30
an Aoine	dé hAoine	Bealtaine	31
an Satharn	dé Sathairn	Meitheamh	30
an Domhnach	dé Domhnaigh	Iúil	31
		Lúnasa	31
		Meán Fómhair	30
		Deireadh Fómhair	31
		Samhain	30
		Mí na Nollag	31

1 a haon	2 a dó	3 a trí	4 a ceathair	5 a cúig	6 a sé	7 a seacht	8 a hocht	9 a naoi	10 a deich
11 a haon déag	12 a dó dhéag	13 a trí déag	14 a ceathair déag	15 a cúig déag	16 a sé déag	17 a seacht déag	18 a hocht déag	19 a naoi déag	20 fiche
fiche a haon		23		25		27		29	tríocha
tríocha a haon		33		35		37		39	daichead
daichead a haon		43		45		47		49	caoga
caoga a haon		53		55		57		59	seasca
seasca a haon		63		65		67		69	seachtó
seachtó a haon		73		75		77		79	ochtó
ochtó a haon		83		85		87		89	nócha
nócha a haon		93		95		97		99	céad

An chéad lá- the first

An dara lá - the second day

An tríú lá- the third day

An ceathrú lá- the fourth day

An cúigiú lá- the fifth day

An séú lá- the sixth day

An seachtú lá- the seventh day

An t-ochtú lá- the eighth day

An naoú lá- the ninth day

An deichiú lá- the tenth day

An t-aonú lá déag- the eleventh day

An dara lá déag- the twelfth day

An tríú lá déag- the thirteenth day

An ceathrú lá déag- the fourteenth day

An cúigiú lá déag- the fifteenth day

An séú lá déag- the sixteenth day

An seachtú lá déag- the seventeenth day

An t-ochtú lá déag- the eighteenth day

An naoú lá déag- the nineteenth day

An fichadú lá- the twentieth day

An t-aonú lá is fiche- the twenty first day

An dara lá is fiche- the twenty second day

An tríú lá is fiche- the twenty third day

An ceathrú lá is fiche- the twenty fourth day

An cúigiú lá is fiche- the twenty fifth day

An séú lá is fiche- the twenty sixth day

An seachtú lá is fiche- the twenty seventh day

Feabhra

Luan	Mair	Céad	Dear	Aoin	Sath	Domh
	1	2	3	4	5	6
7	8	9	10	11	12	13
14	15	16	17	18	19	20
21	22	23	24	25	26	27
28						

Márta

Luan	Mair	Céad	Dear	Aoin	Sath	Domh
	1	2	3	4	5	6
7	8	9	10	11	12	13
14	15	16	17	18	19	20
21	22	23	24	25	26	27
28	29	30	31			

An t-ochtú lá is fiche - the twenty eighth day

An naoú lá is fiche- the twenty ninth day

An tríochadú lá- the thirtieth day

An t-aonú lá is tríocha- the thirty first day

Duine amháin

Beirt

Triúr

Ceathrar

Cúigear

Seisear

Seachtar

Ochtar

Naonúr

Deichniúr

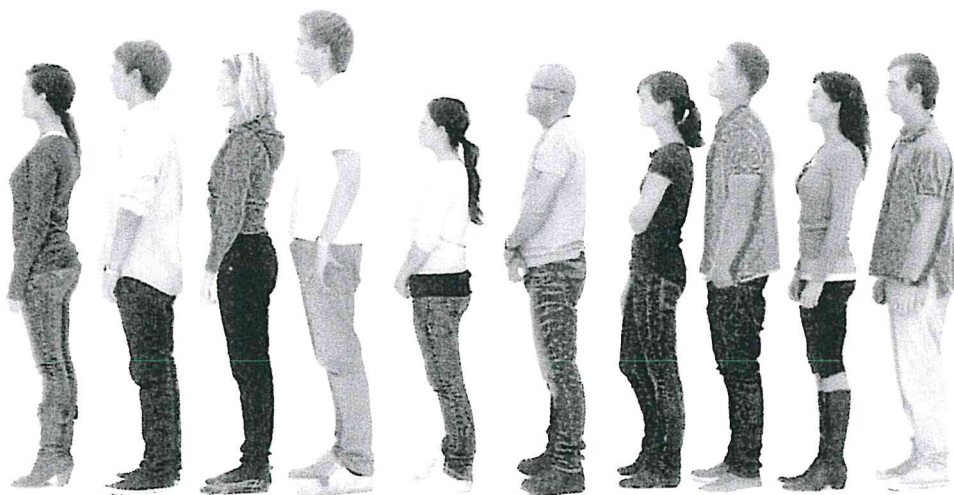

1 uair an chloig- 1 hour

a líonadh- to fill

a rolláil- to roll

a sheiceáil- to check

a shortáil- to sort

abairt uimhreach- number sentence

abhóg- stride

ag déanamh nasc- making a connection

ag íoc an bhille- paying the bill

ag tosú le.....beginning with.....

aghaidh- face

aghaidheanna cláracha- straight faces

aghaidheanna cuara- curved faces

aimsigh- a aimsiú..... find, to find

ainm an chrutha- name of the shape

ainmnigh- name

airde- height

airgead- an t-airgead

an comhartha líide- the minus sign

an dá chuid cothrom lena chéile- both parts equal

an freagra céanna- the same answer

an líon buidéal?- the number of bottles

an líon is lú bonn- the number of coins

an líon is mó/is lú- the greatest number, the smallest number

an méid céanna- the same amount

an mhí dheireanach den bhliain- the last month of the year

an mhí seo caite- last month

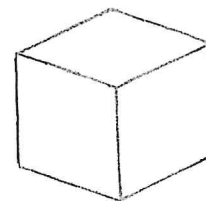
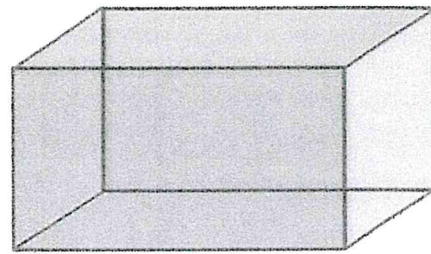
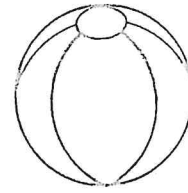

an mhí seo chugainn- next month

an t-iomlán

an tsiombal- the symbol

an tsóinseáil- the change

an tsuim- the sum

an uimhir bhreise- the extra number

an uimhir dheireanach- the last number

Aoine an chéasta- Good Friday

aonad- 8 n--aonad-a unit, 8 units

ar bharr- on top

ar chlé- left

ar comhfhad- equal length

ar dheis- on the right

athainmniú- rename

bain ó- take away

bain triail astu- try them

barr mo mhéire- the top of my finger

beagán níos mó- a little bit more

beartha de dheich- bundles of 10

bonn- boinn-----a coin, coins

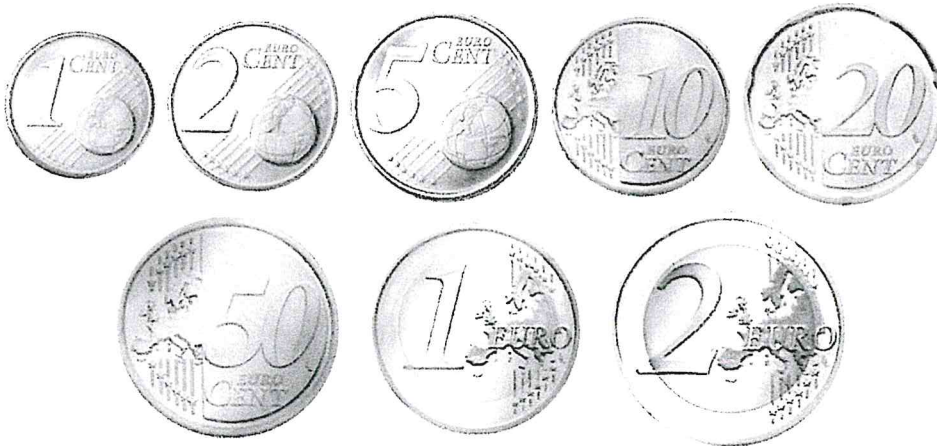
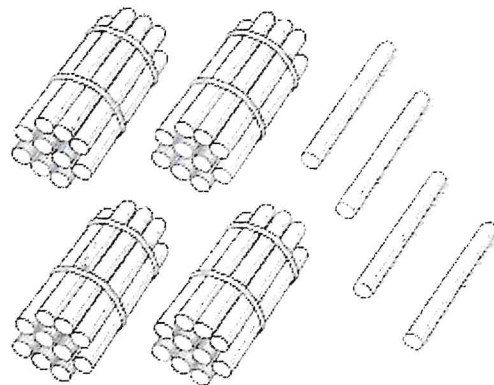
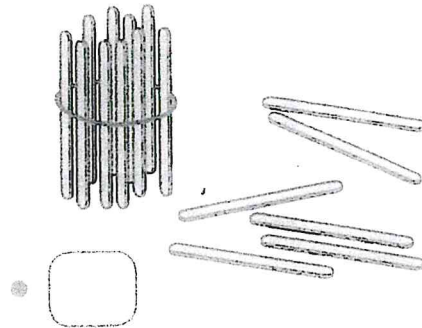

bréagach- false

cad é an difríocht?- what is the difference?

cairt aimsire- weather chart

cé chomh fada is a mhair sé?- how long did it last?

cé mhéad a chosnaíonn?- how much does it cost?

cé mhéad sa bhreis?- how much extra?

cé mhéad uair an chloig idir leath tar éis a haon agus leath tar éis a ceathair?-
how many hours between 1.30 and 4.30?

cé mhéad?- how many?

ceangail le..... - connect to

ceannaíonn- buys

cearnóg- square

cén costas atá ar...what is the cost of?

cén fad sa bhreis?- how much extra?

cén luach atá ag... - what value does have?

cén méid airgid?- how much money?

Chosain- cost

chun tosaigh- forwards

ciorcal- circle

cipíní líreacáin- lollipop sticks

ciúb- a cube

ciúbanna comhghlasáilte- interlocking cubes

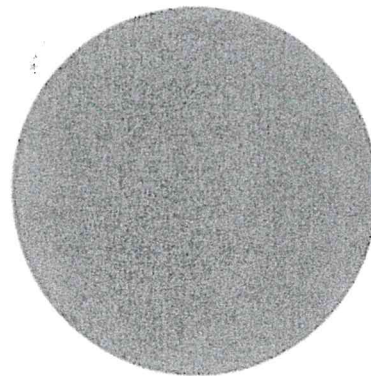
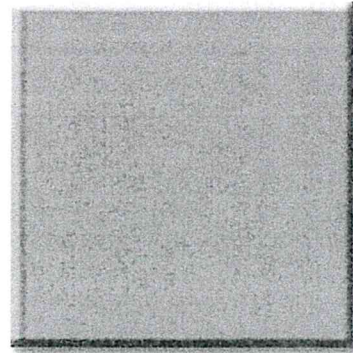

Ciúb

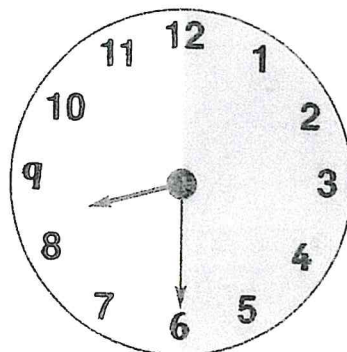
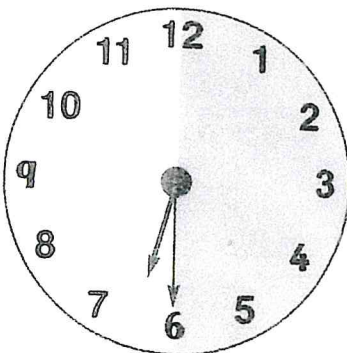
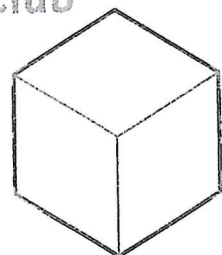

ciúbanna- cubes

ciúbóideach- cuboid

ciumhas- edge

cleachtaigh- practice

cnaipí- buttons

coiméadann- holds

cóimhéid- same size

colún- column

comhair (ar aghaidh)- count on

cónascadh- combine

corruimhir- odd number

cothrom le... equal to....

críochnaigh- a chríochnú----- finish, to finish

crúiscín lítir- litre jug

cruth na n-aghaidheanna- shape of the faces

cruthanna- shapes

cúigeanna- 5's

cúinne- corner

cuir i gcomparáid lena chéile iad- compare them

data- date

de ghnáth- usually

de réir an mheáchain - according to weight

dealú- subtraction

déan deighilt- separate

déan meastachán- estimate

déanfaimid iniúchadh.... we will investigate

deich-deicheanna----- a ten, tens

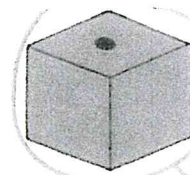
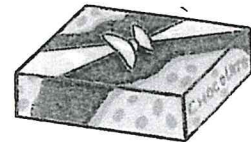
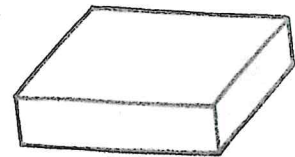
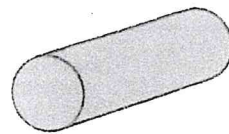
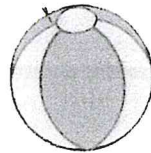

Is ciúb mé.

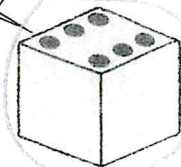

dhá shli dhifriúla- 2 different ways

dhá uair an chloig- 2 hours

díreach i ndiaidh- directly after

díreach roimh- directly before

Domhnach na Cásca- Easter Sunday

Dónna- twos

dronuilleog- rectangle

dúbailtí- doubles

$$9 + 9 = 18$$

dúshlán- challenge

éagsúil i gcruth- different in shape

Eatarthu- between them

eochair- key

Fad- length

fada- níos faide- is faide- long, longer, longest

fágtha ar lár- left out

faobhar- edge

faoin- under

figiúirí

figiúr- figure

fill- fold

fíor- true

folamh- empty

fráma comhairimh- counting
frame

freagra difriúil- different
answer

gar-dhúbailtí- near doubles

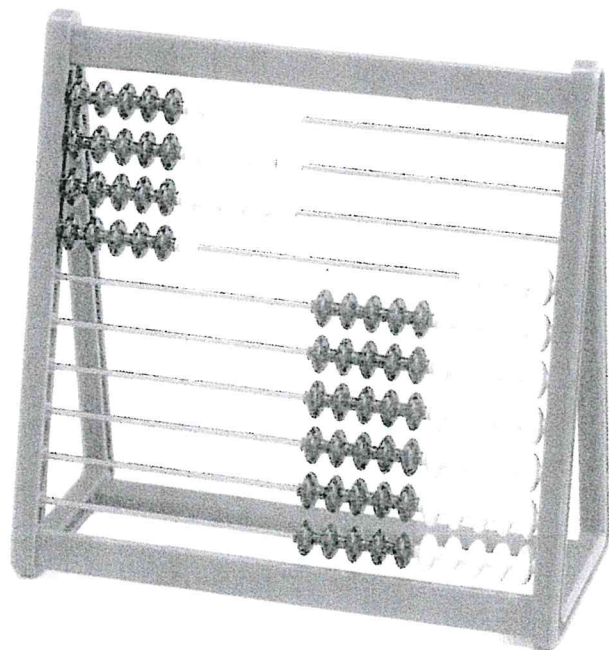

gearr- níos giorra- is giorra----short, shorter, shortest

gearr- short

go leor airgid- enough money

i gceann uaire- in an hour

i gceann leathuaire- in a half an hour

i bpéirí- in pairs

i slite éagsúla- in various ways

idir- between

idir lúibíní- in brackets

imeacht- event

in easnamh- missing

ina dhá leath- in 2 halves

íoc astu- pay for them

is moille- slowest

is tapúla- fastest

is túisce- soonest

istigh- inside

lá breithe- breithlá----- birthday

Lá fhéile Bride- St. Brigid's Day

Lá fhéile Pádraig- St. Patrick's Day

Lá fhéile Vailintín- St. Valentine's Day

lámha an chloig- hands of the clock

le hais an chiorcail- beside the circle

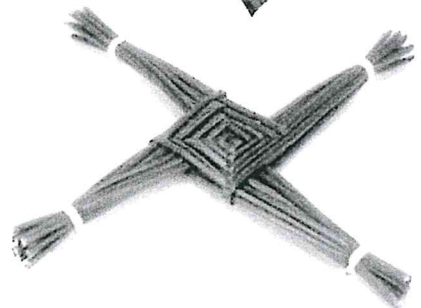
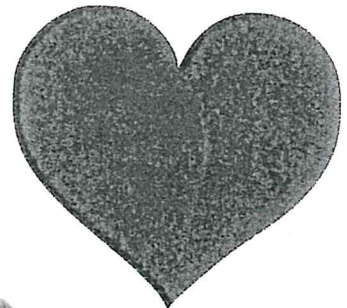

lean na treoracha- follow the instructions

Leath- a half

leathchiorcal- half circle

Leathmhéadar- half metre

Leithead- width

licíní- counters

línigh- draw

lín- number

lín na n-aghaidheanna- number of faces

lín na bhfaobhar- number of edges

lín na reanna- number of corners ar chruth 3D

lín na sleasa- the number of sides

línann- a líonadh-líon sé-----fills, to fill, he filled

línfaidh- will fill

malartaíonn- exchanges

mar a chéile le..... the same as....

mar an gcéanna- the same

marcáil- mark

mblíana d'aois- years of age

meá- weighing scales

méadar- metre

Ciúbóideach

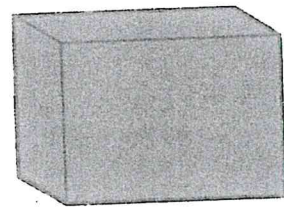

Sorcóir

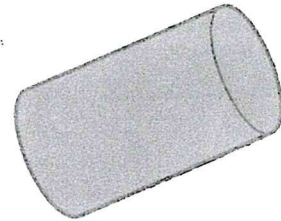

Sféar



Cón

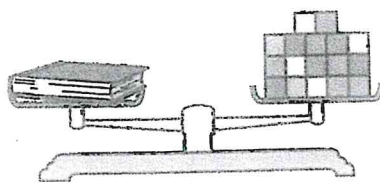

meaitseáil- match

meánn- weighs

mí- míonna- an mhí- deireadh na míosa----- a
month, the month, the end of the month

mo chomhaireamh- my count

mo mheastachán- my estimate

móide- plus

muicín taisce- piggy bank

na hearraí- the goods

na naisc- the bonds

nialas- náid

níos lú ná- less than

níos mó ná- cé mhéad níos mó?

ocht n-asal déag- 18 donkeys

Oíche Shamhna- Halloween night

orduimhir- Cardinal number

os cionn- above

péirí- pairs

poncanna- dots

réise mo láimhe- hand span

réiteach fadhbanna- solving problems

réuimhir- even number

rialóir- ruler

rian mata- Maths Trail

roghnaigh- choose

roimh- before

rollann- rolls

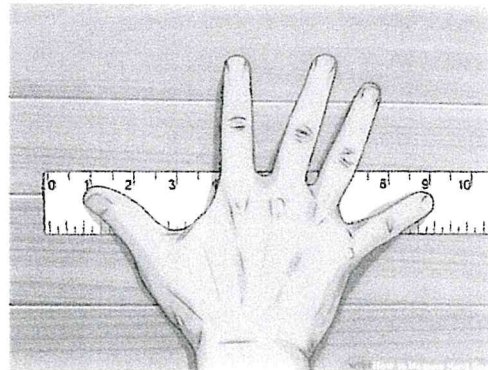
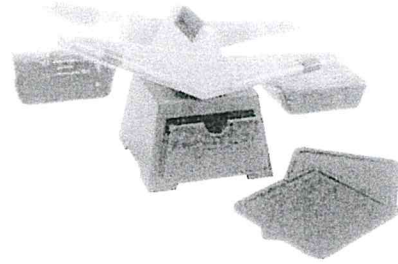

san iomlán- altogether

scáthaithe- shaded in

scríobh- write

scrios amach- rub out

seacht ngabhar déag- 17 goats

siar- back

sféar- sphere

slat mhéadair- metre stick

sleamhnaíonn- slips

slios- side

soip- straws

soitheach- container

sorcóir- cylinder

sprioc-chlár..... target board

spriocuimhir- target number

sraith- row

sreang mhéadair- metre string

stiall mhéadair- metre strip

suimigh- add

tacar- a set

taispeáin - show

taispeáin- a thaispeáint- to show

taobh thiar de- behind

tar éis- after

tarraing- draw

thomhais sí- she measured

timpeall- around

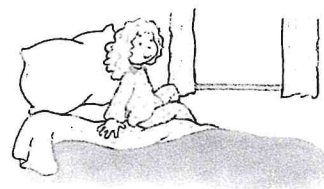
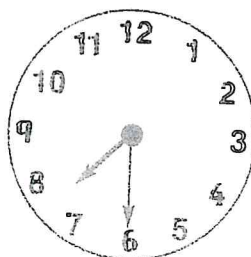
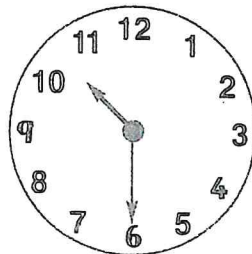
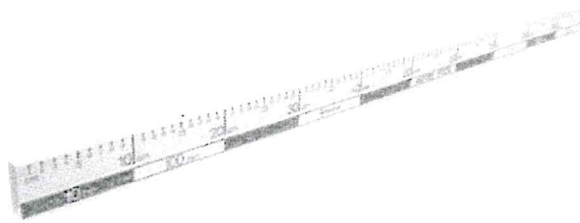

toilleann sé- it holds

tomhas a dhéanamh- to measure

tomhas- measure

tréithe- characteristics

triantán- triangle

tríd- through

uimhir amháin i ndiaidh

uimhir amháin roimh- 1 number before

uimhir nach réuimhir í- a number which is not an even number

uimhir- uimhreacha

uimhirabairt- number sentence

uimhirfhocail- number words

uimhirlíne- number line

uimhirsceal- number story

